

Technical Features

Niteko LED Urban Lighting Fixture

Venere^T

VENERE-T-80W-3070-E22-9011

(35W-BLS.50)

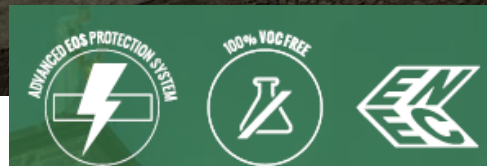



LED Decorative Fixture, contemporary style, **NITEKO** brand, **VENERE^T** model, suitable for wire/rope mounting via stainless steel bracket, with a (actual) maximum power consumption equal to **35W** (tolerance $\pm 5\%$) and power supply of **175/264V a.c. – 50/60Hz**.

Fixture equipped with 32 pcs of **HI POWER LEDs** supplied with constant current up to **500mA**, with a color temperature equal to **3.000K (30)**.

Light source efficiency is of not less than **180lm/W**. Its service life, under optimal operating conditions, is of not less than **100.000 hours (L90B10 – Ta=25°C)** and it features a color rendering index **CRI>70**.

Output luminous flux of lighting fixture with Ta=25°C equal to **3.621lm** (tolerance $\pm 5\%$) in the version with CCT 3.000K. Luminaire efficiency equal to **103 lm/W**. *Fixture equipped with active Constant Lumen Output technology (CLO)*.

High efficiency LED equipped with **secondary high accuracy collimators in PMMA** for the concentration of the luminous beam **with the UPLIGHT and SKYGLOW equal to 0%, without light pollution**. Minimum overall efficiency of the optical unit is of no less than 80%. **Optical system designed to reduce the level of vertical illuminance** on the sides of sidewalks with a glare index $\geq D6$ with the use of external backlight control frame.

High efficiency electronic converters **Philips Xi FP 40W** integrated in power compartment of the lighting fixture, characterized by power factor (PF) greater than **0,97** and MTBF equal to **430.000** hours, thermal protection, short-circuit protection and standard **overvoltage protection** up to **10kV** in common mode, **6kV** in differential mode. Converters are equipped with the inrush-limiting feature called **SoftStart**. LED driver will survive an input overvoltage of 264 ... 320VAC for a period of max. 48 hours and 320 ... 350VAC for a period of max. 2 hours.

Fixture equipped with **separate surge protection device (SPD)** with the following characteristics: rated discharge current $I_n \geq 5$ kA and voltage ≥ 10 kV, maximum impulse current $I_{max} \geq 10$ kA and protection level $U_p \leq 1,5$ kV.

Fixture equipped with thermal protection, which, under abnormal working conditions, reduces the brightness of the light and protects the lamp from overheating thanks to active Driver Temperature Limit (DTL) function.

Inrush current

Specification item	Value	Unit	Condition
Inrush current I_{peak}	21	A	Input voltage 230V
Inrush current T_{width}	300	μs	Input voltage 230V, measured at 50% I_{peak}
Drivers / MCB 16A type B	≤ 21	pcs	Indicative value



Fixture equipped with the protection system against electrical overstresses, owned by NITEKO, called **Advanced EOS Protection System**, which allows having a **failure rate among the lowest in the sector** and guaranteeing high reliability and durability over time. Non-metallic materials and components present in the product, from a chemical point of view, are fully compatible with LED. They do not release VOC (volatile organic compounds) that can influence performance, stability and color temperature during operation: thus the fixture result in being **“VOC FREE”**.

All components are free of mercury, lead and other toxic substances and are fully recyclable.

The fixtures of the VENERE series are certified according to the norms:

LVD Directive 2014/35/EU	EN 61000-4-5:2006
EN 60598-2-3: 2003 / A1:2011	EN 61000-4-6:2009
EN 60598-1:2015 / A1:2018	EN 61000-4-8:1993 / A1:2001
EMC Directive 2014/30/EU	EN 61000-4-11:2004
EN 61000-3-2:2014	EN 61547:2009
EN 61000-3-3:2013	EN 62493:2010
EN 61000-4-2:2009	EN 55015:2013
EN 61000-4-3:2006 / A1:2008 / IS1:2009	EN 62471:2010



Class II fixture with protection of optical unit and power compartment equal to **IP66**, impact resistance degree equal to **IK08**, with operating temperatures equal to a maximum +45°C and a minimum -40°C, size equal to **520(d)x147(h¹)x238(h²)mm** in the version **VENERE^T** that consists of:

- **die-cast aluminium body**, smooth without fins, grids, cuts, holes or other design elements on the outside where dirt can accumulate;
- **openable without the use of tools** thanks to a bottoms closure, with incorporated heat-sink equipped with cooling fins sized so as to ensure a long life and maximum efficiency of the diodes;
- luminaire body subjected to sandblast process, cataphoresis and polyester powder coating color **RAL 9011**, resistant to ultraviolet radiation, mechanical impact, corrosion, depreciation, abrasion, flaking and saline fogs, with full 15-year warranty on all metal parts;
- a silicone rubber gasket fitting on the geometry of the component ensures the tightness of the power compartment;
- **SCREEN**: 4mm transparent tempered glass with a silicone rubber gasket which allows to open-close the body without changing them. Both are resistant to UV rays and weather conditions;
- **the optical part is separated from driver part** by a physical hermetic partition;
- **electronic compartment opens downwards** (open part is kept without additional human assistance) without changing position of the luminaire and close without tools and consists of the modular power supply;
- **safety switch** that automatically disconnects the power supply when the luminaire is opened;
- LED modules fixed on frame with screws and can be replaced with the help of screws without usage of glue, paste or other special measures, the usage whereof may violate warranty terms;
- the luminaire is supplied with connected **cables H07RN-F** (Core - Stranded flexible annealed bare copper conductor. Insulation - Rubber, with higher electrical, mechanical and thermal performances, EI4 type) 2x1,5mm² length 1m.



Fixtures are equipped with optional devices, suitable for **Remote Control** with interface components integrated in the lighting body:

The **Automatic Regulation (PRG)** is managed by a luminous flux self-regulator, incorporated in the lighting body and included in the power compartment, suitable for the control and reduction of the lighting fixture's luminous flux from 10% to 100% in its maximum value, without using dedicated cables. The device is equipped with a fully programmable micro-controller, capable of managing the power compartment, with LED sources of any wattage. The operation is based on the possibility of defining, through user-defined programming, from 1 to 5 brightness levels based on time set through a configuration software. The system calculates the "Midnight point" considering the period of time in which the device is powered and, over this, enables the reduced speed periods, considering the settings selected through software.

The system has the following automatic features:

- Power on;
- Power off;
- Testing of proper functioning;
- Luminous flux regulation.

The **Cable regulation (DIM/DALI)** happens through reserved cables:

The DIM module provides the candlepower regulation through 1-10V analog signal.

Using the interface module DALI is possible a light smart regulation considering the specific requirements of the space. DALI is a digital communication protocol of the adjustable electronic converters. This new standard interface represents a distributive intelligence system. This means that the light emission values of different illuminating engineering settings and the light sources collection are stored inside the electronic converters. The control system has the feature of recalling the specific setting and the electronic converter that identifies its light emission level and responds in relation to it. It is also possible to recall every single electronic converters. In order to guarantee the interchangeability between the different DALI components realized by different producers, the DALI interface has been included in the E appendix of the IEC 929 law as a non-proprietary standard compliant to the modern lighting control requirements.



Lighting fixtures are equipped with **7-poles NEMA socket connector** with the following technical characteristics:

MECHANICAL

- Conforms to dimensional requirements of ANSI C136.41-2013
- Offer a 5 and 7 position version
 - 5 position: 3 power contacts + 2 dimming/signal contacts
 - 7 position: 3 power contacts + 4 dimming/signal contacts
- Power contacts terminated to 14AWG stranded wire per UL1015 or UL3321
- Signal Contacts terminated to 18AWG stranded wire per UL1015 or UL3321

ELECTRICAL

	<u>Power contacts</u>	<u>Dimming contacts</u>
• Current rating:	15 A max	0.10 A max
• Voltage rating:	480 VAC/DC	10 VAC/DC
• cUR recognized to UL 773		

MATERIALS

- Power contacts: Copper Alloy, tin over nickel plating
- Dimming contacts: Copper Alloy, gold over nickel plating
- Housing: Glass filled PBT, UL 94V-0 flammability rated

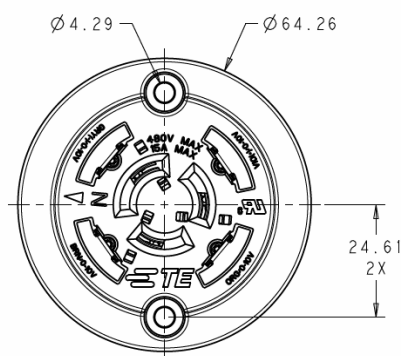
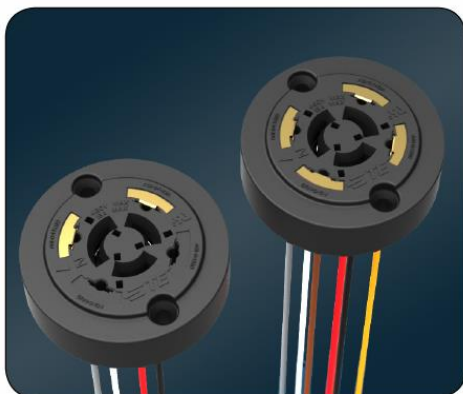

Luminaire identification via QR code is available on request (product name, light output, CCT, type of optics, number of LEDs, power input, current, frequency, power factor, safety class, CRI, brand, production date). The QR code is attached by the factory to the luminaire and packaging. The additional two stickers contained in the package contents can be attached individually



Technical Features	
Brand	Niteko
Series	VENERE ^T
Model	VENERE-T-80W-3070-E22-9011 (35W) + KM-VENERE-BLS.50
Description	Led Street and Urban Lighting Fixture
Mounting	Wire/rope mounting with the diameter from 6 to 10mm
Maximum effective power	35W
Power Supply	175/264 V a.c. – 50/60 Hz Electronic power supply integrated into lighting fixture with $\eta > 95\%$ efficiency
Power Supply LED modules	Constant power supply up to 500mA
Power Factor	PF > 0,98 in nominal operating mode PF > 0,92 when operating in 50% dimming mode
Insulation Class	Class II
Light source	32 pcs of HI POWER LEDs
Optic	LED modules equipped with high precision secondary collimators for light beam concentration. Optical system designed to reduce the level of vertical illuminance on the sides of sidewalks with the use of external backlight control frame.
Laser security Class	1M
Nominal luminous Flux	6.036lm ("30" Version : CCT = 3.000K @Ta=25°C)
Output luminous Flux	3.621lm ("30" Version : CCT = 3.000K @Ta=25°C)
Light Source Efficiency	$\eta > 180$ lm/W
Luminaire efficiency	$\eta > 103$ lm/W
Color Temperature	"30" Version: CCT = 3.000K
Color Rendering Index	Ra > 70
Service Life	L90B10 – Ta=25°C
IR & UV radiations	Absent
Inorganic Toxic Elements	Absent
Turning on / restart	<ul style="list-style-type: none">• $t_A < 1$sec.• $t_R < 1$sec.
Material	<ul style="list-style-type: none">• FIXTURE: die-cast aluminium body• SCREEN: tempered glass, minimum thickness 4 mm
Color	RAL 9011 (sandblast process, cataphoresis and polyester powder coating)
Protection Degree	Optic Unit: IP66 / Power Compartment: IP66 Impact resistance degree: IK08
Fixture size and weight	520(d)x147(h ¹)x238(h ²)mm / 10,0 kg
Box size and weight	580x570xh280 mm / 10,5 kg
Certificates	CE, RoHS, ENEC

PHOTOMETRIC CURVE

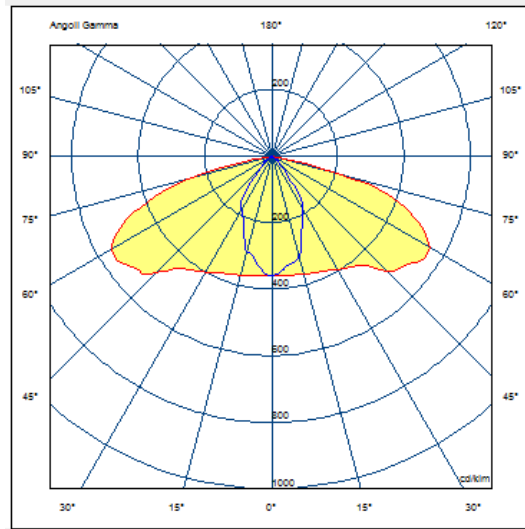

E22 OPTIC WITH KM-VENERE-BLS.50

Technical drawings

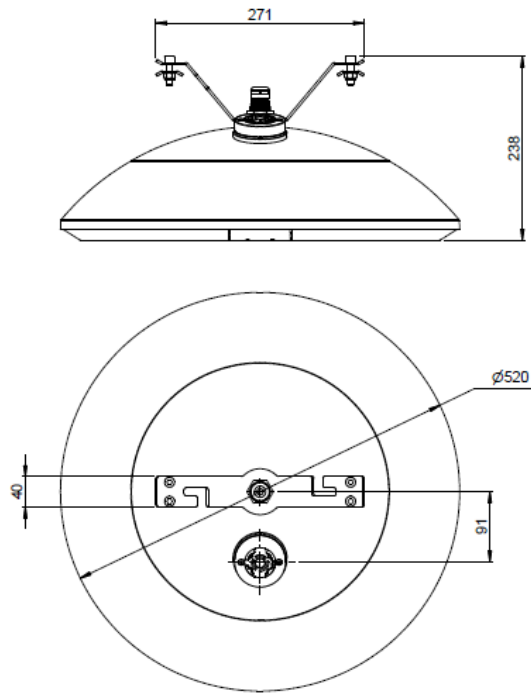

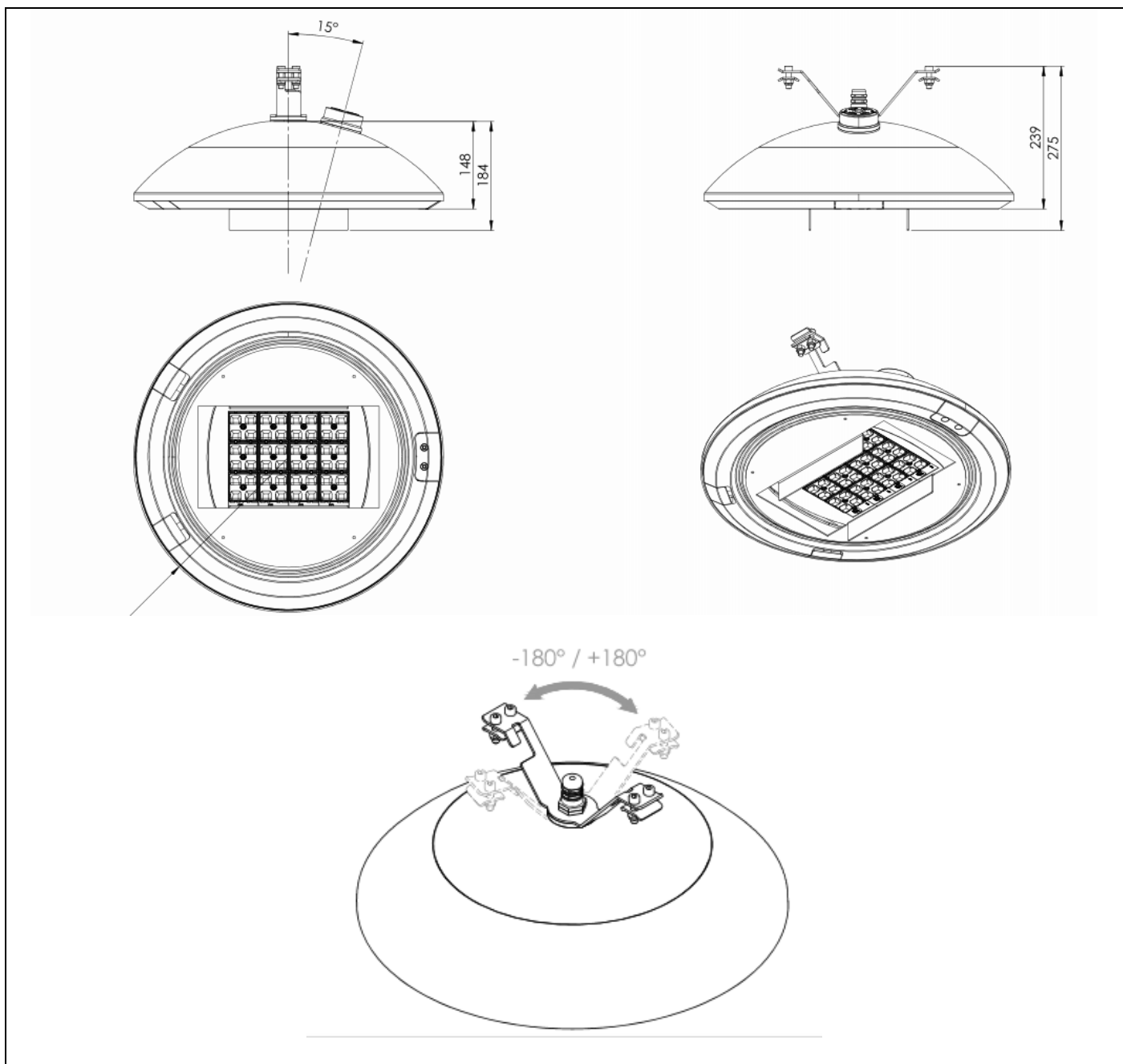

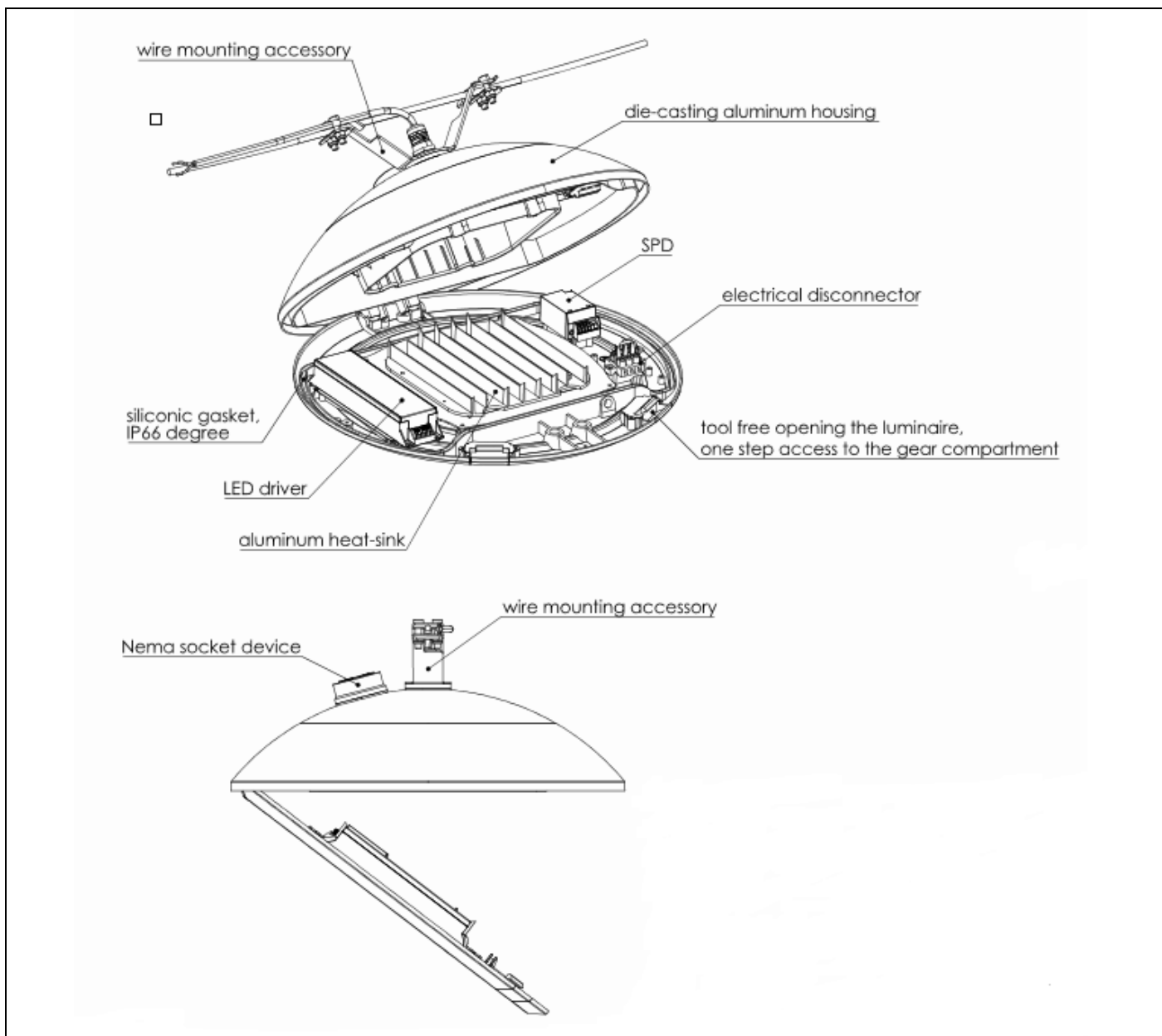

Product pictures

